

solex



	Solex 3	Solex 10	Solex 15
	9 - 60VDC		
	85 mA (@12V) 40 mA (@24V) 25 mA (@48V)	165 mA (@12V) 88 mA (@24V) 45 mA (@48V)	510 mA (@12V) 240 mA (@24V) 120 mA (@48V)
	Current values @ 12, 24 and 48V are +/- 10% Požor pri kraju		
	0.28mm ² - 2.5mm ²		
	-25°C ~ +70°C		
	ABS VO & PC		
	Podstawa S = Type A = (IP54*) Podstawa DIJ = Type B = (IP33C (IP65*)) 1Hz		

*Product exceeds minimum requirements of EN54-3

See www.fulleon.com

Le produit dépasse les exigences minimum de EN54-3

Voir www.fulleon.com

Das Erzeugnis erfüllt die Mindestanforderungen von EN54-3.

Stehet www.fulleon.com

Il prodotto supera i requisiti minimi previsti dalla norma EN54-3

Vedi www.fulleon.com

Produkt overtreff de minimale vereisten van EN54-3.

Zie www.fulleon.com

El producto excede los requisitos mínimos de la norma EN54-3

Véase www.fulleon.com

Produkten överträffar minsta krav enligt EN54-3

Se www.fulleon.com

Parametry techniczne produktu przekraczają minimalne wymagania

normy PN EN54-3, szczegóły www.fulleon.com

www.fulleon.com

Fulleon Ltd, Cwmbran, South Wales, U.K.

25-6018-E



VDS

G207018

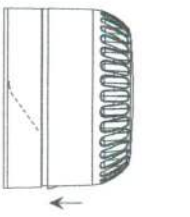
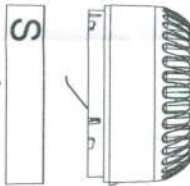
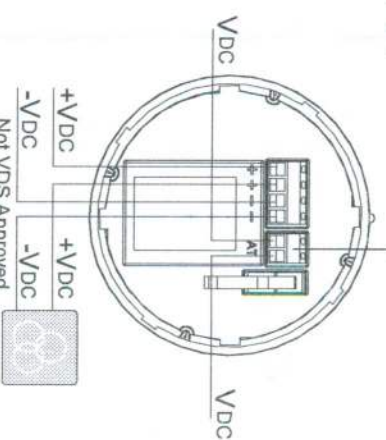
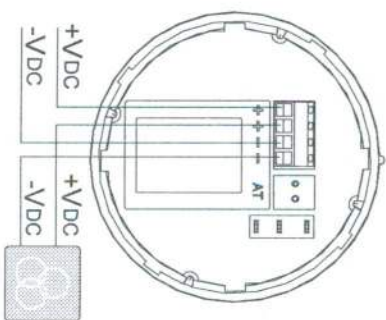
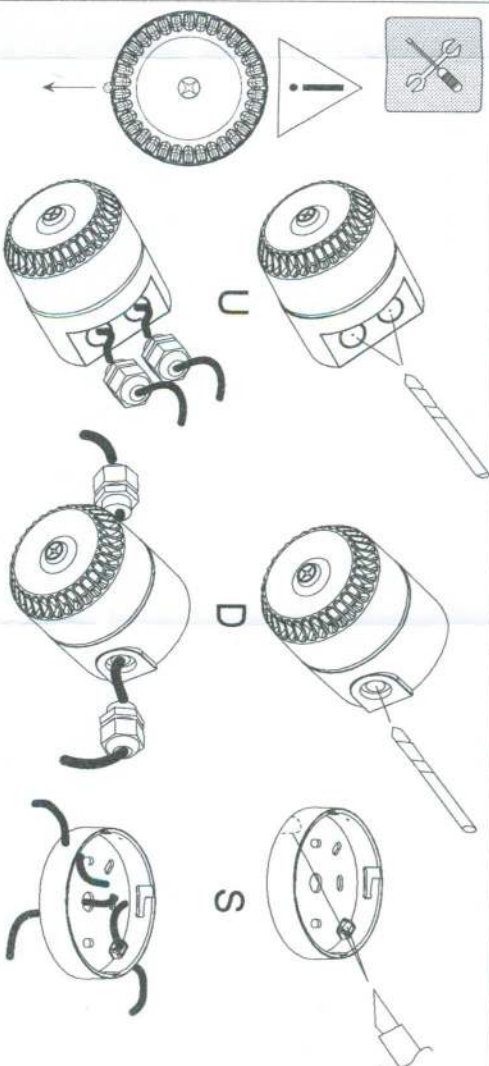
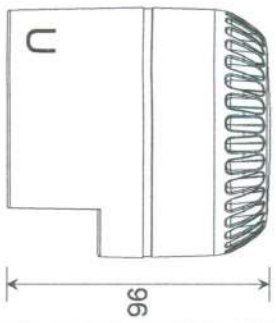
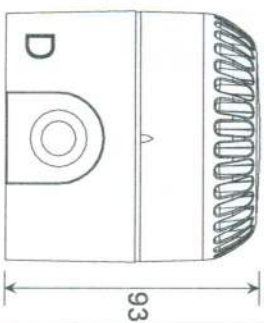
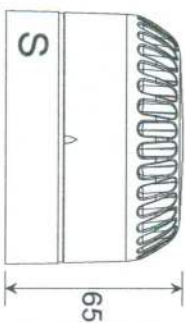
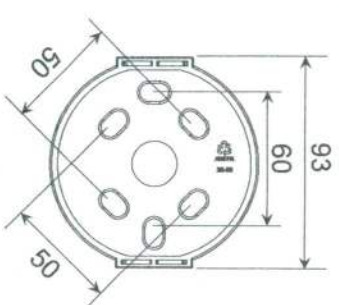

Not VDS Approved
Nie objęty certyfikatem Vds